

SAPPHIR





GSM 220X250

HORIZONTAL MANUAL MITER

BAND SAW MACHINE

*Photo may feature machine with optional accessories

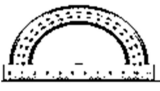
CUTTING CAPACITY

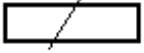
	0°	45°	60°
	220 mm	160 mm	95 mm
	200 mm	140 mm	75 mm
	180 x 250 mm	140 x 150 mm	75 x 95 mm

TECHNICAL SPECIFICATIONS

<i>Main Motor</i>	: 1.1 KW
<i>Gearbox</i>	: Worm Gear Reducer PMRV 063
<i>Coolant Motor</i>	: 0,9 kW
<i>Coolant Tank Capacity</i>	: 15 liters
<i>Blade Speed</i>	: 25 – 100 m/min
<i>Blade Dimensions</i>	: 2500 x 27 x 0,9 mm
<i>Machine Weight</i>	: 250 Kg
<i>Machine Dimensions</i>	: 640 x 1450 x 1400 mm
<i>Table Height</i>	: 915 mm

STANDARD ACCESSORIES

Inverter

Provides to adjust blade speed up to
Work piece diameter, thickness and hardness.



Rotating Table

Our machine has rotating table to turn angle.
So you do not have to move material while
you want to make miter cutting.

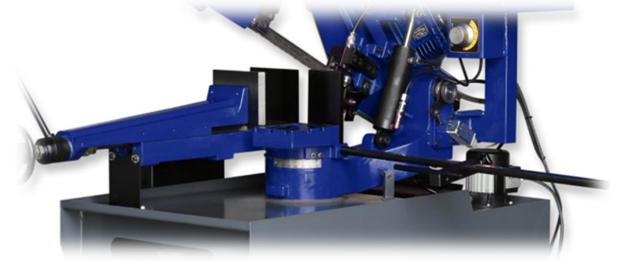

Fast Clamping vise



Swarf Brush

Removes swarfs to keep clean the
wheel sand blade.



Hydromechanical Blade Tension



Blade Bedding with Bearings and Carbide Plate

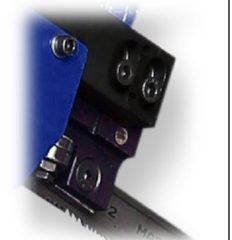

S.A.P. (Italy) Brand Coolant Pump

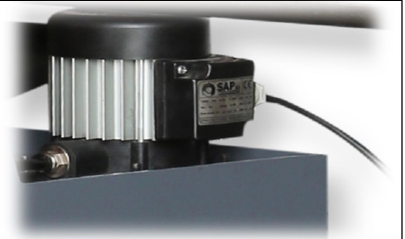

Fast Clamping Arm



Arm for Lifting Bow



Manometer



60 cm Long Material Stopper System

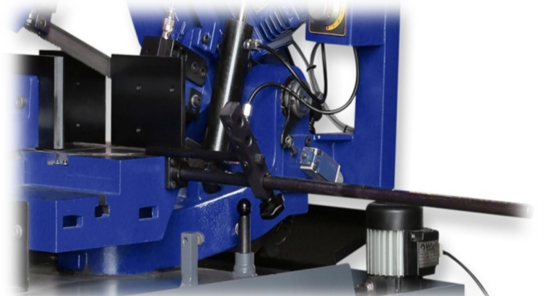

Adjustable Bow Down Speed



Bow Cylinder



Easy Readable Angle Ruler

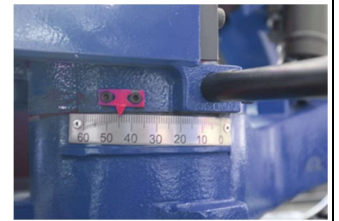

Bow Cover Switch

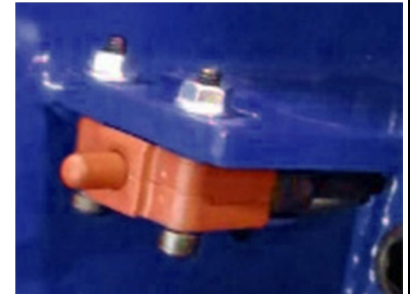

Blade Tension Switch



Wheel Bedding with Bearing



Dismountable Saw Frame

24 VDC Wiring at Control Panel

Automatic Stop When;

- The covers are open
- Blade is broken
- Blade tension is low

SAFETY EQUIPMENTS

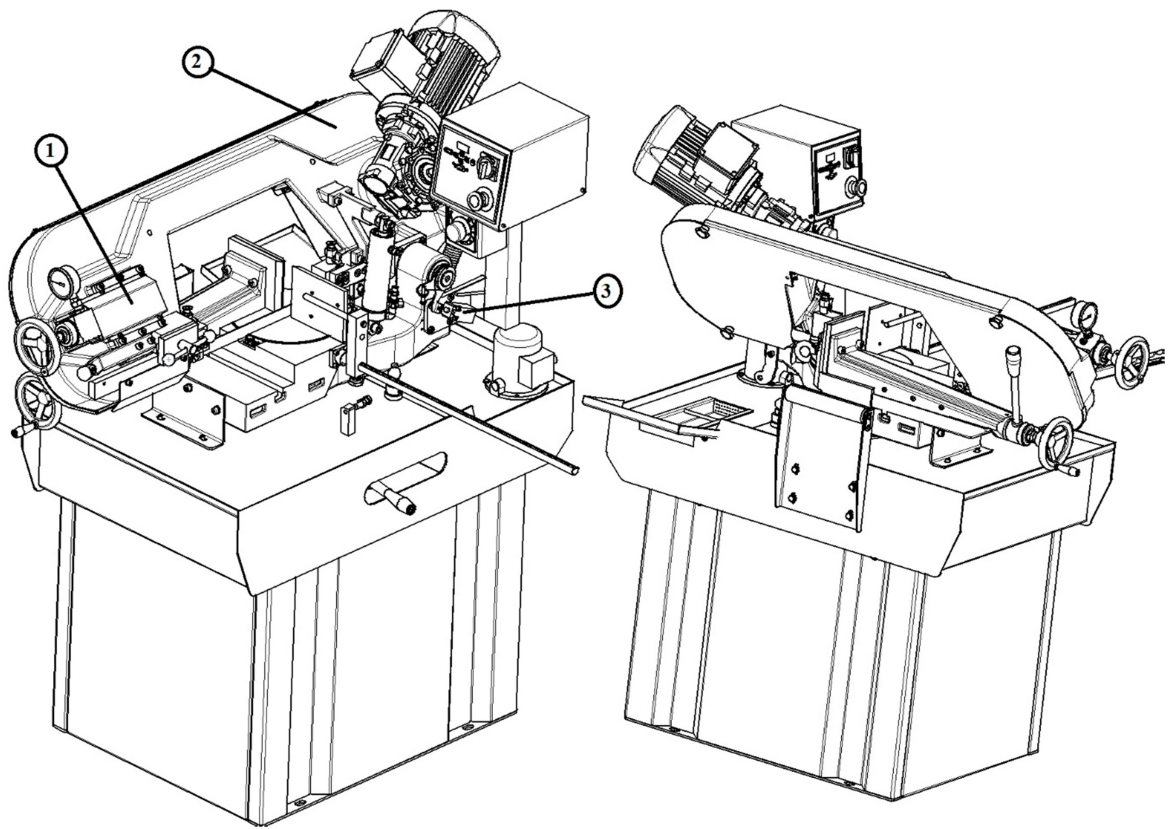

TERMS

Delivery (After Receipt of written PO) :

Type of Delivery :Exwork

WARRANTY CONDITIONS

The machine is under the warranty of SAPHIR. For a period of 2 years for mechanical parts, 1 year for electric and electronic parts from the date of purchase. This warranty is subject to all of the terms and conditions listed below:

1. This warranty is valid only if the **Warranty Registration Form** is filled in and returned to the manufacturer or its authorized dealer within **two months after the** date of purchase.
2. The obligation of the manufacturer under this warranty shall be limited to repairing or replacing components which proves defective and which our examination shall disclose to our satisfaction to be defective.
3. Defects due to improper operation, misuse, neglect, alteration, irregular voltage conditions, inadequate wiring, improper installation (**all electrical and electronic components, all electrical motors etc.**) and due to accidents or any damage caused by transportation, flood, fire, natural disasters, theft are not included in this warranty and are strictly the responsibility of the purchaser.
4. Any part returned to SAPHIR or its authorized dealer under the terms of this warranty shall be on the basis of transportation charges prepaid by the customer and must be accompanied by a record of the machine model code and serial number.
5. This warranty does not apply to the following components; band saw blade, blade pressure pads or brackets and blade guide bearings **because of being consumables.**
6. Manufacturer and authorized dealer cannot be blamed within maximum repair period for the material or moral damage. Apart from that act the period as Warranty Conditions and there will not be done any retroactive requirement.

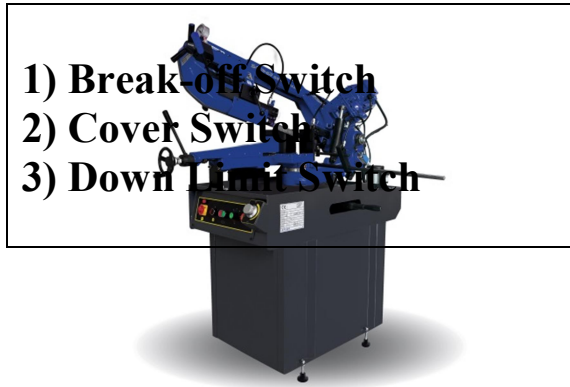

SAPHIR BANDSAW MACHINES
Hanli Merkez Mah. Hatip Sok. No:32
Arifiye/Sakarya/TURKEY
Phone: +90 264 276 59 16
Fax: +90 264 276 59 19
www.saphirbandsaw.com
sales@saphirbandsaw.com